

Montage- anleitung



Panelbefestigung ThermoEimer

WBH5B



TEXAS TRADING GmbH
Landsberger Straße 33 · 86949 Windach
Tel. 08193/9313-0 · Fax 08193/9313-33

Bitte beachten Sie, dass im Falle des nicht bestimmungsgemäßen Gebrauchs bzw. bei Modifikationen jede Haftung erlischt.

Universal Panelhalter WBH5B passend für die TEXAS TRADING Abtrennungen:

① TEXAS TRADING Pferdezaunelement

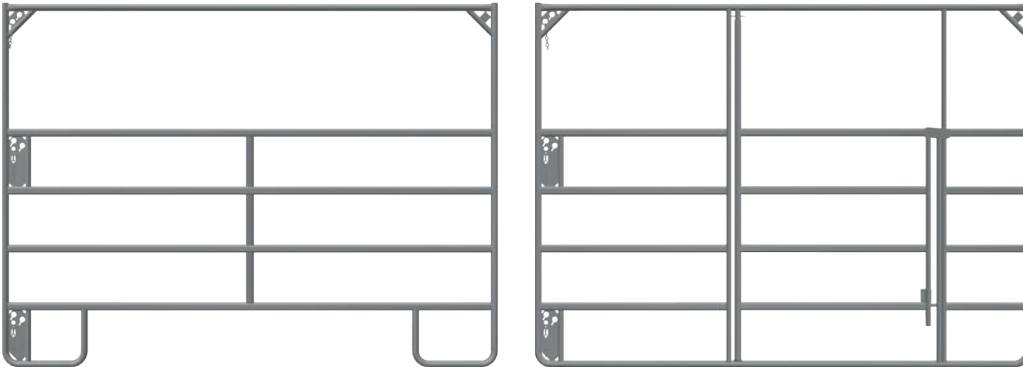

② TEXAS TRADING Standard Zaunelement

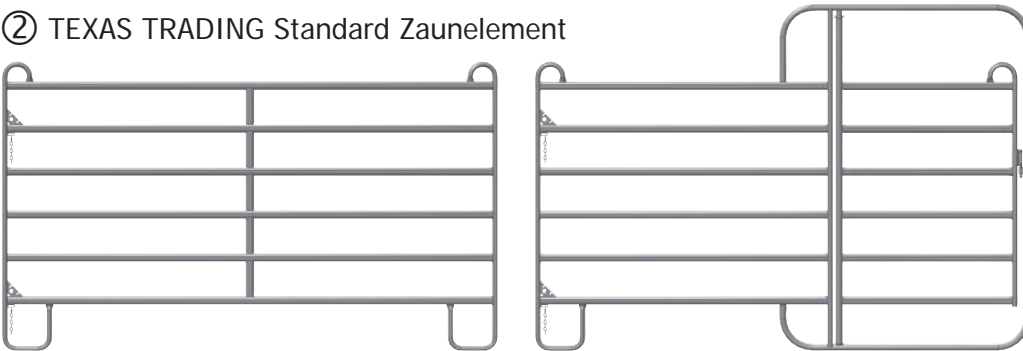



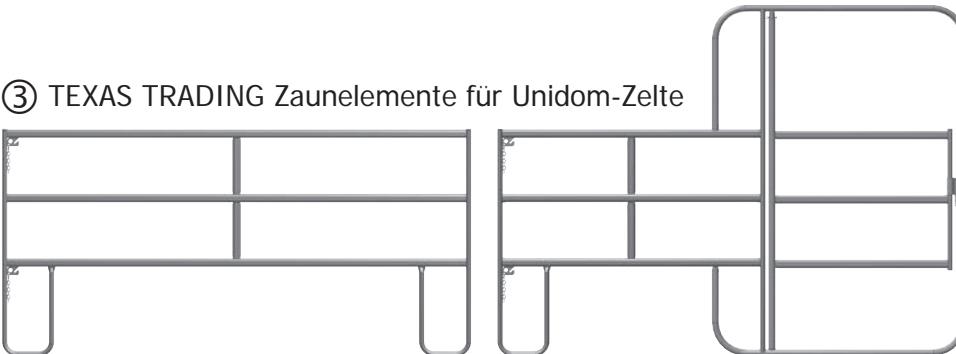





③ TEXAS TRADING Zaunelemente für Unidom-Zelte



④ TEXAS TRADING PG Weidetore



Stückliste

Abbildung	Bezeichnung	Menge	Erforderlich für Montage an:
	UPHO Haken uni oben Teil 1	2	<ul style="list-style-type: none"> • alle Abtrennungen
	PHTEU Haken mit Lasche uni unten WBH5 Teil 2	2	<ul style="list-style-type: none"> • alle Abtrennungen
	Sechskantschraube M10 x 20 Teil 3	2	<ul style="list-style-type: none"> • PG Weidetore
	Sechskantschraube M10 x 25 Teil 4	2	<ul style="list-style-type: none"> • Standard Zaunelement • PG Weidetore
	Sechskantschraube M10 x 40 Teil 5	2	<ul style="list-style-type: none"> • alle Abtrennungen
	Sechskantschraube M10 x 45 Teil 6	2	<ul style="list-style-type: none"> • Standard Zaunelement • PG Weidetore
	Sechskantschraube M10 x 60 Teil 7	2	<ul style="list-style-type: none"> • Pferdezaunelement • Zaunelement für Unidom-Zelt
	Selbstsichernde Mutter M10 Teil 8	2	<ul style="list-style-type: none"> • alle Abtrennungen
	Mutter M10 Teil 9	6	<ul style="list-style-type: none"> • alle Abtrennungen

① Montage am TEXAS TRADING Pferdezaunelement

Erforderliches Werkzeug:

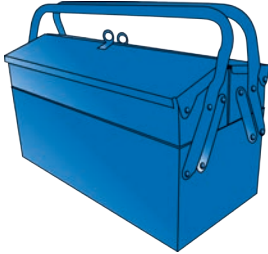

17er Schlüssel / Nuss



Erforderliche Teile:

Teil 1



Teil 2



Teil 5



M10x40

Teil 7



M10x60

Teil 8



selbstsichernde
Mutter M10

Teil 9 (4 x)



Mutter M10

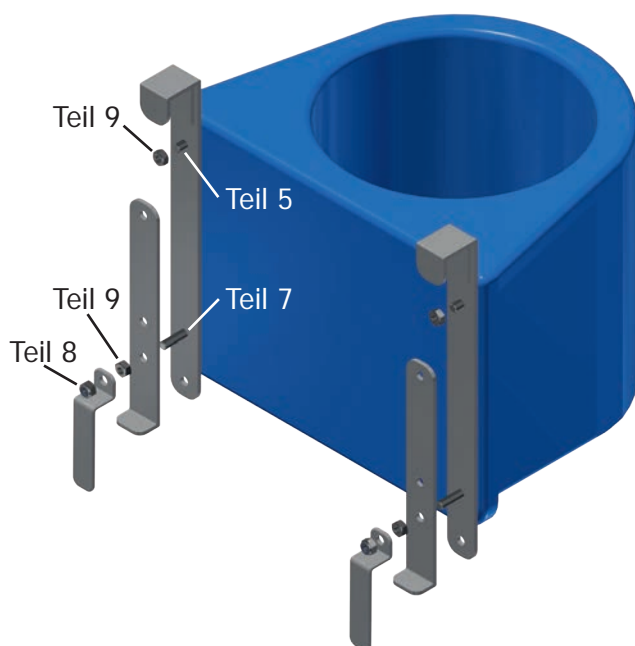

② Montage am TEXAS TRADING Standardzaunelement

Erforderliches Werkzeug:

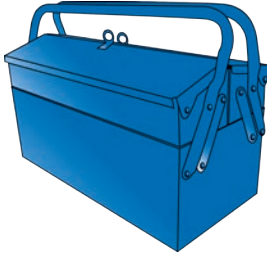

17er Schlüssel / Nuss

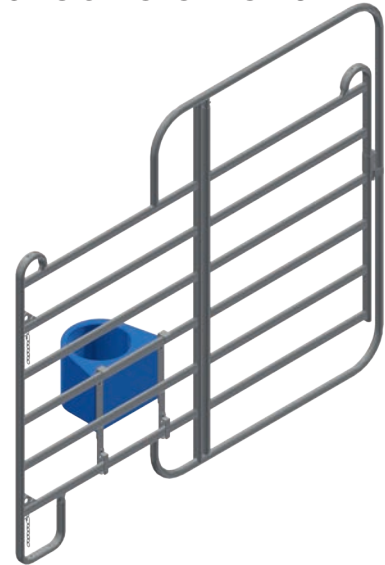

Erforderliche Teile:

Teil 1



Teil 2



Teil 4



M10x25

Teil 5



M10x40

Teil 6



M10x45

Teil 8



selbstsichernde
Mutter M10

Teil 9 (4 x)



Mutter M10

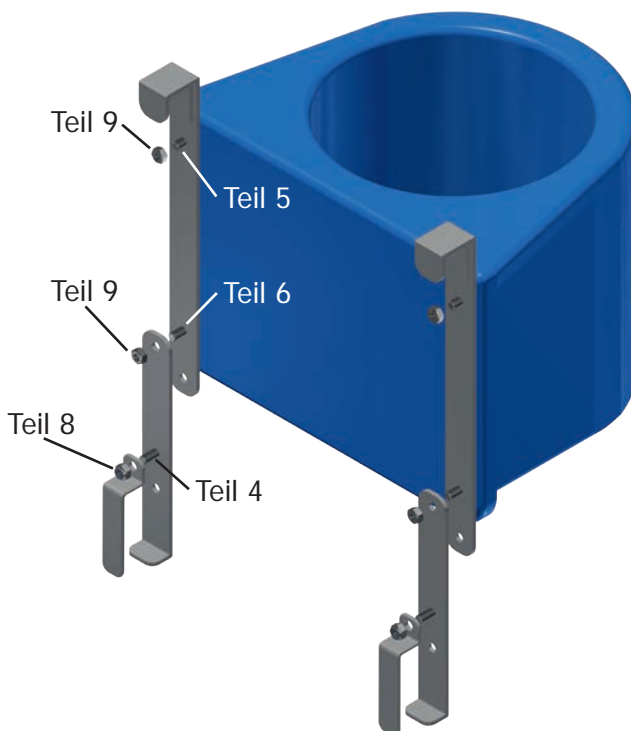

③ Montage am TEXAS TRADING Zaunelement für Unidom-Zelt

Erforderliches Werkzeug:

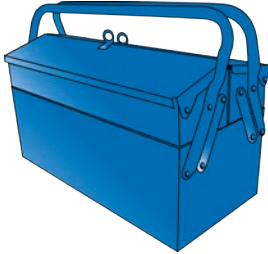

17er Schlüssel / Nuss

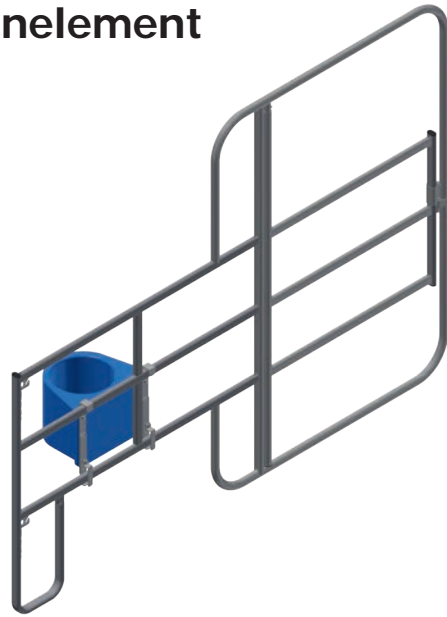

Erforderliche Teile:

Teil 1



Teil 2



Teil 5



M10x40

Teil 7



M10x60

Teil 8



selbstsichernde
Mutter M10

Teil 9 (4 x)



Mutter M10

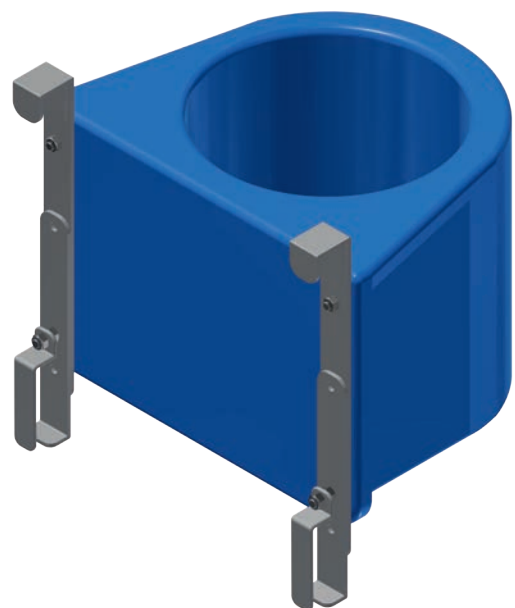
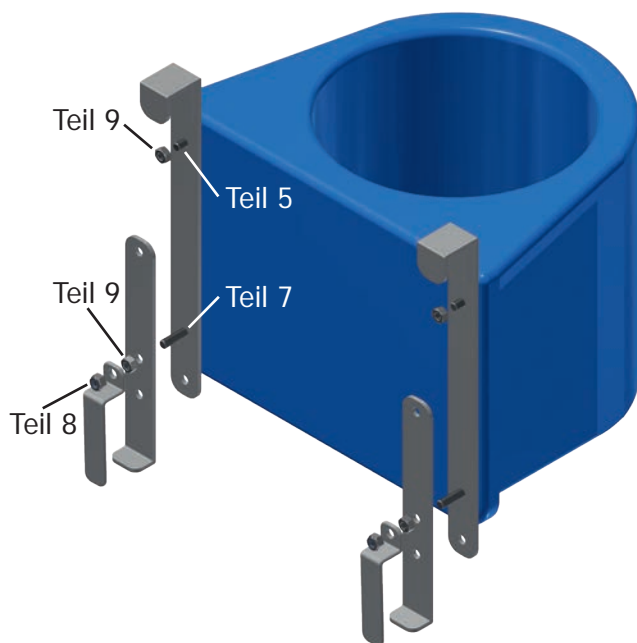

④ Montage am TEXAS TRADING PG Weidetor

Erforderliches Werkzeug:

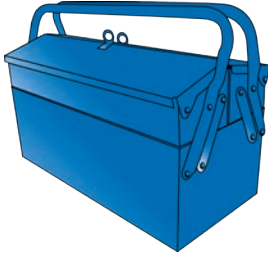

17er Schlüssel / Nuss

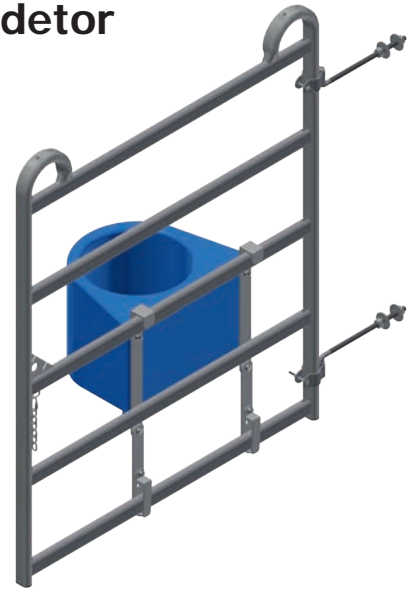

Erforderliche Teile:

Teil 1

Teil 2

Teil 3

Teil 4

Teil 5

Teil 6

Teil 8

Teil 9 (6 x)



M10x20



M10x25



M10x40



M10x45



selbstsichernde
Mutter M10



Mutter M10

